



Installation Instructions

Thank you for purchasing this anti-sway bar kit. Please read through these instructions before installation.

Front Anti-Sway Bar Kit for Workhorse W Series Diesel models

part #1259-107
1-5/8" diameter

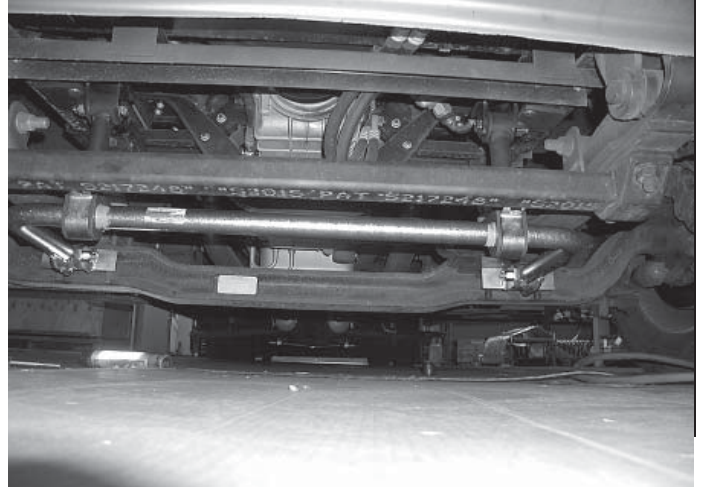

INTRODUCTION

Thank you for purchasing this anti-sway bar kit. This kit is designed to improve the handling characteristics of your Workhorse by reducing the body roll and balancing the weight transfer during cornering. The anti-sway bar kit is engineered for long life and trouble-free performance. For maximum suspension control, use this kit along with our rear anti-sway bar kit.

All the hardware needed for installation is included in this kit. Refer to the PARTS LIST in these instructions to identify the parts.

SUGGESTED TOOLS

The following tools are suggested to complete the installation procedures:

- General hand tools
- 1/8", 1/2" drill bits
- 1/2" drill
- Torque wrench

WARNING

Failure to follow these instructions can result in property damage, personal injury or even death.

- If raising the vehicle to install the anti-sway bar, always support the vehicle with jack stands at both frame rails or at the rear axle before working underneath. Ensure that the jack stands are securely positioned, and are rated at or above the weight of the vehicle.
- The installer must read the instructions and use all bolts and parts supplied. Use only the parts supplied by ROADMASTER to install this kit.
- Minor modifications are sometimes necessary due to slight vehicle variations, even for the same year, make and model.
- Regardless of year, make and model, a wide range of options for specific applications may or may not interfere with the installation. It is the installer's responsibility to make certain that equipment is not damaged once the suspension solution travels through the full range of motion. Failure to ensure adequate clearance could result in non-warranty property damage, personal injury or even death.
- If running changes were made by the manufacturer after this kit was designed, there may be weldments, braces, gussets, or other structural items which interfere with the installation. It is the installer's responsibility to allow for these running changes without sacrificing the structural integrity of the anti-sway bar. Failure to securely fasten the anti-sway bar could result in property damage, personal injury or even death.
- ROADMASTER will not be responsible for any damage or injury resulting from any modification or alteration.
- Check ALL the fasteners for tightness before and after road testing the vehicle.
- Do not use this document for custom fabrication, as it may not show all parts or structural components.
- Do not use an air impact wrench when re-installing bolts, as stripped threads may result.
- This anti-sway bar is only warranted for the original installation. Installing a used anti-sway bar on another vehicle is not recommended and will void the warranty.

PARTS LIST

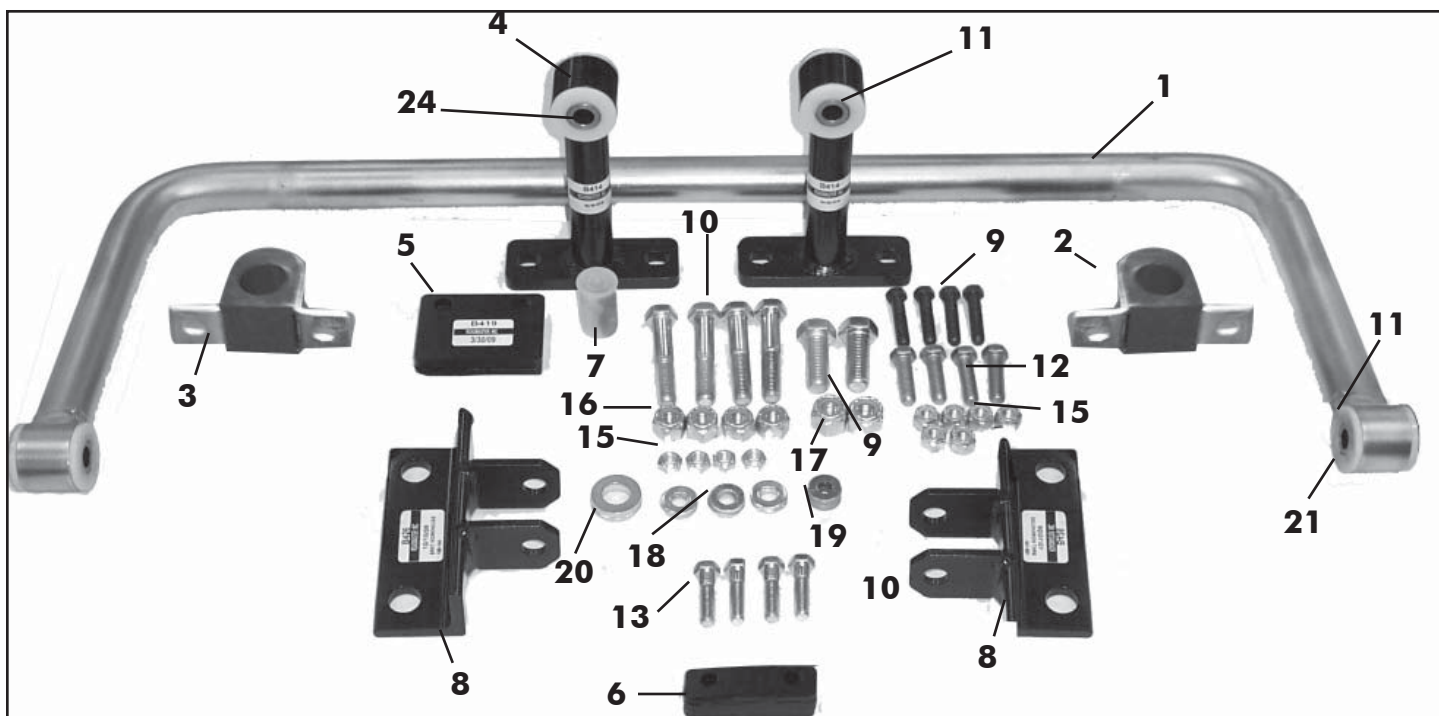

Part #1259-107

Part #	Description	Qty	Part #	Description	Qty
1	580055-00 Anti-sway bar	1	14	350256-02 Locknut, 7/16"	4
2	205222-10 Poly bushing	2	15	350259-00 Nut, 1/2"	6
3	B141 U-clamp	2	16	350263-00 Locknut, 5/8"	4
4	B414 Droplink W22, front	2	17	350265-00 Locknut, 3/4"	2
5	B419 Bracket clamp W22	2	18	350304-80 Washer, 3/8"	8
6	B423 Bracket shim W22	4	19	350308-20 Washer, 1/2"	12
7	400011-30 Grease AQUALUBE	1	20	350314-20 Washer, 3/4"	4
8	B426 Bracket axle W-22 ft	2	21	205503-00 Metal sleeve	4
9	350096-80 Bolt, 1/2" x 1-3/4" NC	4	22	*350184-00 3/4" x 3" Bolt	2
10	350163-00 Bolt, 5/8" x 3-1/2"	4	23	*B751 Bracket frame left	1
11	205209-00 Poly bushing	8	24	*B750 Bracket frame right	1
12	350097-00 Bolt, 1/2" x 2"	2			
13	350076-80 Bolt, 7/16" x 2"	4			

* not pictured

Free Extended Warranty

You must accurately and completely fill out and mail the product registration card within thirty (30) days from the date of purchase to qualify for your warranty. **If we receive your card, completely and accurately filled out, within twenty (20) days from the date of purchase, we will extend the coverage to a total of two (2) years at no extra charge.**

Your product registration is an important record for ROADMASTER to keep in touch with you. It also enables us to expedite any future claim, update or recall that may arise concerning our products.

INSTALLATION

The following instructions must be followed in the order listed to ensure a proper installation and to preserve the ROADMASTER warranty.

1. Install the axle brackets.

Remove the two front U-bolt nuts on each side. Install the B426 axle brackets and reinstall the nuts. Do not tighten at this time (Figure 1).

2. Install the driver's side frame bracket.

Note: for the Workhorse 2007 chassis, the rear steering box has been moved. We have supplied you with a $\frac{3}{4}$ " bolt in place of the 30mm bolt. Drill a $\frac{3}{4}$ " hole and mount the bracket.

Locate and remove the 30mm bolt from the rear steering box bracket inside the driver's side frame rail. Use this bolt to attach the B750 (using front hole) with the tabs closest to front of chassis. Torque the nut back to factory specs. Drill a $\frac{1}{2}$ " hole through the frame rail and install using a $\frac{1}{2}$ " x 2" bolt (350097-00) and secure with a washer and nut. Torque to 80-100 ft.-lbs. Assemble the spacer plate and clamp plate as shown using $\frac{7}{16}$ " bolts, washers and nuts. Tighten the clamp bolts to 40-50 ft.-lbs.

3. Install the passenger side frame bracket.

The passenger side bracket is directly opposite the driver's side bracket. Locate a $\frac{7}{8}$ " hole inside the passenger side frame rail. Install the passenger side frame bracket (B751) inside the frame rail using one $\frac{3}{4}$ " bolt (350386-00); secure with washer and nut. Torque to 80-100 ft.-lbs. Drill a $\frac{1}{2}$ " hole through the frame rail and install the second bolt (350097-00, $\frac{1}{2}$ " x 2"). Secure it with a washer and nut; torque to 80-100 ft.-lbs. Assemble the spacer plate and clamp plate as shown using $\frac{7}{16}$ " bolts, washers and nuts. Tighten the clamp bolts to 40-50 ft.-lbs. (Figure 2).

4. Mount the bar.

Attach anti-sway bar to the axle plates using $\frac{5}{8}$ " bolts (350163-00). Tighten to 30-45 ft.-lbs. (Figure 3).

5. Assemble and connect the drop links.

Install bushings (205209-00) and sleeves (205503-00) into the drop links and attach to the frame brackets on each side. Tighten to 30-45 ft.- lbs.(Figure 4).

6. Connect the anti-sway bar to the drop links.

Lubricate the inside of the anti-sway bar bushings with the provided grease (Figure 5). Install the anti-sway bar bushings and U-clamps on the bar. Connect the anti-sway bar to the drop links using the bolts (350096-80) provided. Torque to 60-75 ft.lbs. (Figure 4).

Figure 1

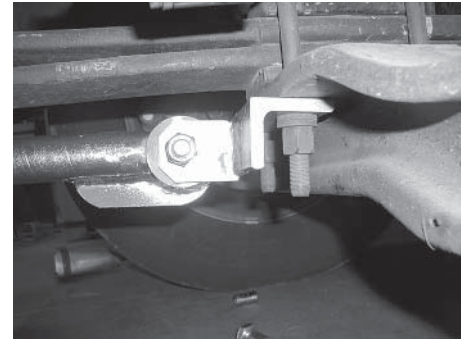

Figure 2

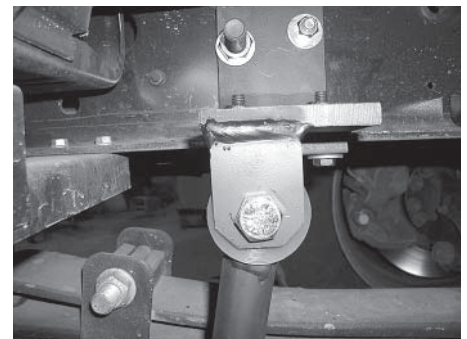

Figure 3

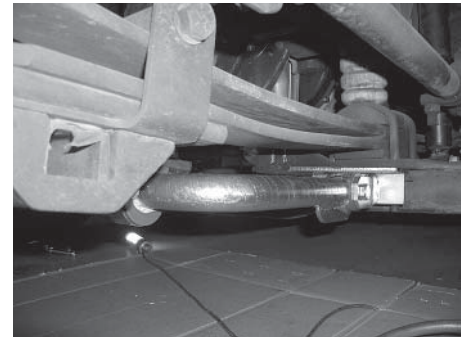
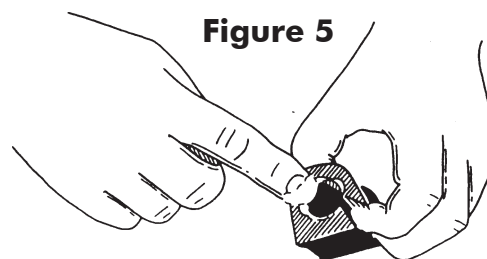
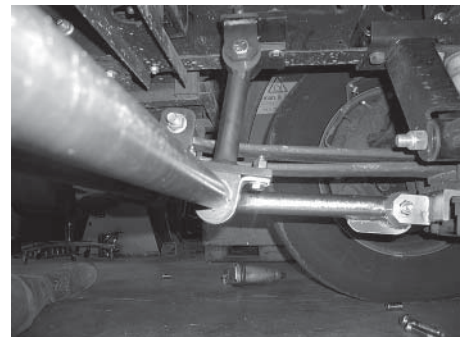

Figure 4



INSTALLATION

7. Tighten the remaining fasteners.

Tighten the axle clamps to the factory torque specifications.

8. Road test.

Test drive, listen for any unusual noises. Re-inspect installation.



WARNING

After road testing, re-check all fasteners for proper tightness — if a fastener has worked loose or fallen off, re-tighten or replace it. Without all kit components properly tightened or in place, the anti-sway bar will not stabilize the vehicle at full capacity, which may cause reduced cornering ability or other reductions in vehicle handling or performance.

Failure to follow these instructions may result in property damage, personal injury or even death.



WARNING

The anti-sway bar is not a load-bearing component

Do not tow or hoist the vehicle using the anti-sway bar or its mounting brackets as attachment points. The anti-sway bar is not designed to carry the weight of the vehicle and may collapse, which will damage the anti-sway bar components, the suspension, or other components. The vehicle will detach or fall, which may cause severe personal injury.

Failure to follow these instructions may result in property damage, personal injury or even death.

LIMITED WARRANTY

1. WARRANTY

1a. WARRANTY OF CONFORMITY AT TIME OF SALE

ROADMASTER, Inc. warrants that at the time of sale of this product it will be free from defects in material and manufacture and will conform to ROADMASTER'S specifications for the product.

1b. CONDITIONAL ONE-YEAR WARRANTY

In addition to the preceding time-of-sale warranty, if the product registration card is completely and accurately filled out and mailed to ROADMASTER within thirty (30) days of purchase, ROADMASTER will provide an additional warranty that for a period of one year after sale the product will remain in good working order, PROVIDED THAT the product is installed and maintained in accordance with ROADMASTER'S instructions and is not subjected to: (a) alteration or unauthorized repairs or repairs by anyone other than ROADMASTER or a ROADMASTER-authorized service center, (b) misuse, abuse, commercial use, or improper maintenance, (c) Acts of God (including without limitation hurricanes, tornadoes, floods, or other severe weather or natural phenomena), (d) failures due to products not supplied by ROADMASTER, or (e) other treatments, uses, or installations for which the product was not intended. This warranty extends only to the first retail purchaser-consumer of the product and is not transferable.

EXTENDED WARRANTY PERIOD: If ROADMASTER receives the product registration card, completely and accurately filled out, within twenty (20) days of purchase, ROADMASTER will enlarge the one-year warranty period in the preceding paragraph to a period of two years.

2. DISCLAIMER OF OTHER WARRANTIES

The preceding warranties are the exclusive and sole express warranties given by ROADMASTER. They supersede any prior, contrary or additional representations, whether oral or written. No agent, representative, dealer or employee has the authority to alter or increase the obligations or limitations of this warranty. Any implied warranties, including the WARRANTY OF MERCHANTABILITY and any WARRANTY OF FITNESS FOR A PARTICULAR PURPOSE, are limited in duration to thirty days or the term of the applicable express warranty provided above, whichever is longer.

Some states do not allow limitations on how long an implied warranty lasts, so the above limitation may not apply to you.

3. EXCLUSIVE REMEDY FOR ANY NONCONFORMITIES

If during the applicable Warranty Period, the product does not conform to the preceding Warranties, notify ROADMASTER as provided below, and within a reasonable time ROADMASTER will provide, at its option, one of the following: (1) replacement components for any nonconforming or defective product or components or (2) the percentage of the purchase price for the nonconforming product equal to the percentage of the Warranty Period remaining when ROADMASTER is notified of the nonconformity. ROADMASTER will, at its option, (a) use new and/or reconditioned parts in performing warranty repairs and making replacement products, (b) use parts or products of original or improved design in the repair or replacement. If ROADMASTER repairs or replaces a product, its warranty continues for the remaining portion of the original Warranty Period or 60 days from the date of the return shipment to the customer, whichever is greater. All replaced products and all parts removed from repaired products become the property of ROADMASTER. ROADMASTER will not provide, and will not be liable for, labor, costs of removal or reinstallation of components, disposal, shipping, freight, taxes, or other incidental charges.

THESE REMEDIES ARE THE EXCLUSIVE AND SOLE REMEDIES FOR ANY BREACH OF WARRANTY.

For any breach of warranty, the Owner must telephone ROADMASTER at 1-800-669-9690 within thirty (30) days after discovering the nonconformity. Do not return any product without first calling ROADMASTER and getting a return authorization number. Returned products must include the return authorization number and a copy of the original invoice, bill or other proof of the date of purchase. The date of purchase must coincide with the original warranty registration card on file. ROADMASTER will authorize (a) shipment of the product to ROADMASTER or (b) repair or replacement at the nearest warranty service center—in both cases with shipping at your expense. Do not purchase replacement parts or pay for repair labor—you will not be reimbursed. Compliance with the requirements of this paragraph is a condition to coverage under the Warranty: if these requirements are not complied with, ROADMASTER will have no obligation to provide any remedy for any breach of warranty.

4. DISCLAIMER OF INCIDENTAL AND CONSEQUENTIAL DAMAGES

IN NO EVENT SHALL ROADMASTER BE LIABLE FOR ANY INCIDENTAL, SPECIAL, INDIRECT OR CONSEQUENTIAL DAMAGES, WHETHER RESULTING FROM NONDELIVERY OR FROM THE USE, MISUSE OR INABILITY TO USE THE PRODUCT OR FROM DEFECTS IN THE PRODUCT.

Some states do not allow the exclusion or limitation of incidental or consequential damages, so the above limitation may not apply to you.

5. APPLICABLE LAW

This Warranty will be interpreted, construed, and enforced in all respects in accordance with the laws of the State of Washington, without reference to its choice of law rules. The U.N. Convention on Contracts for the International Sale of Goods will not apply to this Warranty.

6. SEVERABILITY

If any provision of this warranty is found to be invalid or unenforceable, then the remainder shall have full force and effect, and the invalid provision shall be partially enforced to the maximum extent permitted by law to effectuate the purpose of the agreement.

7. ADDRESS FOR NOTICES TO ROADMASTER

ROADMASTER, Inc., 6110 NE 127th Ave., Vancouver, WA 98682

This warranty gives you specific legal rights, and you may also have other rights which vary from State to State.