



Serial Number

Please read BOTH these Installation Instructions and the General Instructions before attempting to install or operate this equipment.

- Blue Ox® towing products and accessories are intended to be installed by Blue Ox® Dealers who are familiar with our products and have the equipment necessary and knowledge to do "fit work". When necessary Blue Ox® Dealers can be found at www.blueox.us or by contacting our 24/7 Customer Care Department at (402) 385-3051 or toll free (888) 425-5382.
- Many Blue Ox® Baseplates are designed to use existing holes and hardware to mount the baseplate to the towed vehicle. Even though bolts are there, do not assume they are adequate for baseplate mounting. Always use hardware supplied in the hardware kit and existing hardware specified in the Baseplate Installation Instructions.

Attachment Tab Height: 14 1/4"
Attachment Tab Width: 24"

Bolt Torque Specifications
Torque in Foot-Pounds per Metric Bolts

Bolt Size	Grade 8.8	Grade 10.9
6MM	6	8
8MM	16	22
10MM	31	40
12MM	54	70
14MM	89	117

Confirm the towability and pre-towing procedures for your vehicle with the owner's manual or contact the vehicle's manufacturer for specific towing procedures. You can also contact REMCO for additional information at 1(800)228-2481.

Bolt Torque Specifications
Torque in Foot-Pounds per Inch Bolts

Bolt Size	Grade 5	Grade 8
1/4"	10	14
5/16"	19	29
3/8"	33	47
7/16"	54	78
1/2"	78	119
5/8"	154	230



! WARNING

Failure to read and follow these instructions could result in separation of the towed vehicle from the tow bar, causing property damage, loss of towed vehicle, personal injury or death.

BX1012

2004-05 Acura TSX

Installation Instructions

Parts List

Ref. No.	Qty.	Part #	Description
1	1	61-5930	Weldment, Baseplate, BX1012
2	6	61-5208	3/8" Nutplate, with Wire
3	2	201-0368	3/8-16 x 1 1/4" Bolt, Grd. 5, ZP
4	6	201-0440	3/8-16 x 1 1/2" Bolt, Grd. 5, ZP
5	8	203-0010	3/8" Lock Washer, ZP
6	2	202-0003	3/8-16 Hex Nut
7	2	201-0553	1/4-20 x 1/2" Hx. Wshd, Type F Screw
8	2	201-0192	#10-32 x 1/2" Slot, Rd. Hd. Screw
9	2	203-0054	#10 Lock Washer
10	2	202-0047	#20-32 Hex Nut
11	2	101-5822	Adapter, 4 Way Connector
12	2	62-3469	Attachment, Assembly, SF/ LB (R)
	2	226-0046	Baseplate Safety Cable, 36" CL III (Not Shown)
	2	229-0359	Quicklink, 3/8, ZP (Not Shown)
	2	290-0437	Cap Plug, Black (Not Shown)

Tools Required

10MM Socket	Hack Saw
12MM Socket	Small Flat Screwdriver
9/16" Socket	Vise Grips
13/32" Drill Bit	LOCTITE Red
Phillips Screwdriver	

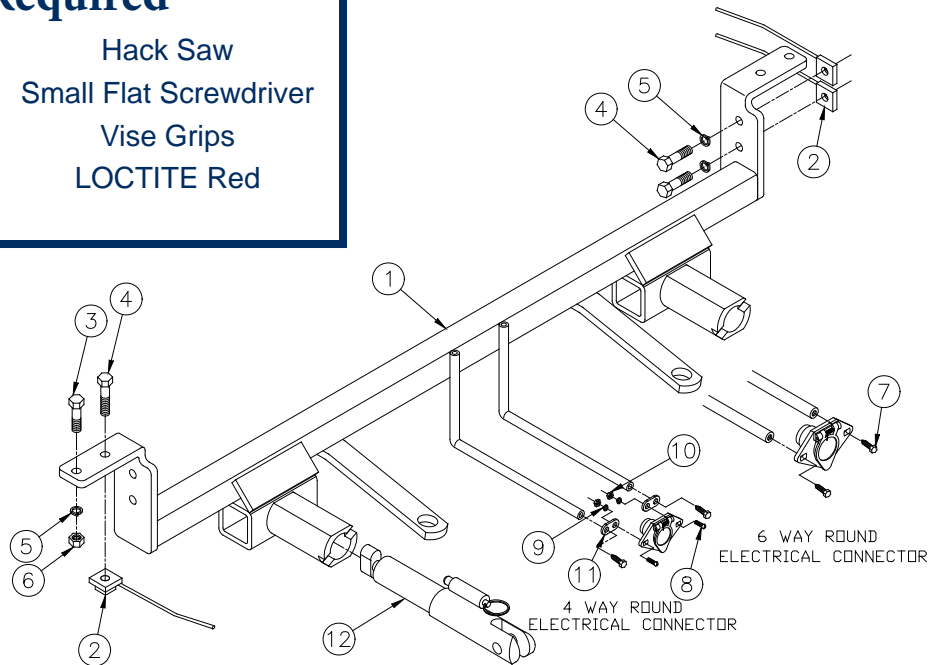

Important:

Use only genuine factory replacement parts on your baseplate. Do NOT substitute homemade or non-typical parts. If a bolt is lost or in need of replacement, for your safety and the preservation of your baseplate, be sure to use a replacement bolt of the same grade (In most cases it will be Grade 5, please reference the parts list above). Replacement parts may be ordered through your nearest Blue Ox® Dealer or Distributor, or call our 24/7 Customer Care Team at (402)385-3051.

BX1012
2004-05 Acura TSX
Installation Instructions

Removable Tabs:

Due to the design of the removable tabs, the RangeFinder II tow bar can not be used. Adapters, except the BX8833 and the BX88151, can not be used with this baseplate.

Instructions:

The headlight assembly and front fascia are removed and reinstalled for the baseplate installation. Drilling is required.

The dimensional variations between otherwise identical vehicles can be considerable. While the baseplate was designed for easy installation, it may be necessary to tailor the baseplate slightly to compensate for auto manufacturer's tolerances. These minor adjustments may include filing a hole slightly, bending electrical rods, and/ or bending end plates.

The BX8848 4 - Diode Wiring Kit is recommended for this vehicle.

Installation Instructions



1. Remove the twelve pushpins from the black plastic cover on the top side of the fascia. Lift the cover and set it and the pushpins aside to be reinstalled later.

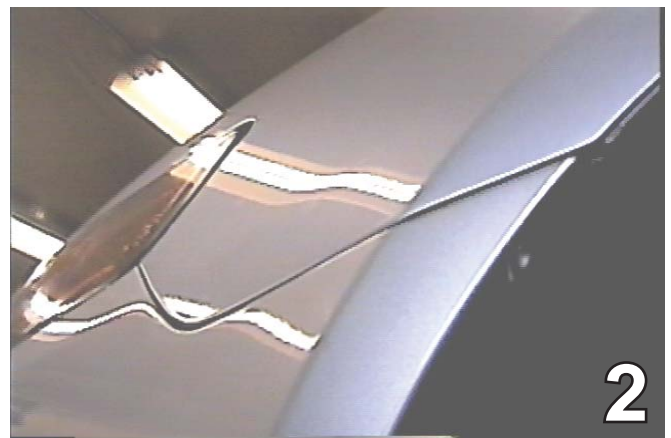

2. Remove one Phillips screw from the fascia's corner, just above the front tire. Do this to both sides of the vehicle.

BX1012
2004-05 Acura TSX
Installation Instructions



3. Remove the four metric bolts from the bottom edge of the front fascia with the 10MM socket and seven pushpins. Pull the fascia forward, set it and the pushpins aside to be reinstalled later.



4. Using the 10MM socket, remove two metric bolts just above the headlight assembly. Do this to both sides of the vehicle. Set the bolts aside to be reinstalled later.

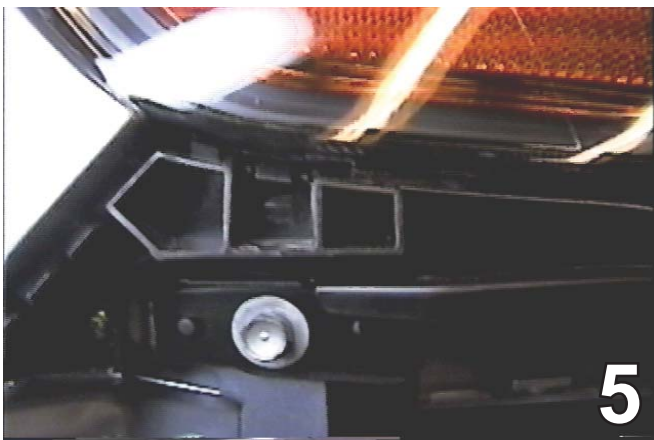

5. Just below the blinker on the headlight assembly, remove one metric bolt and one metric bolt on the lower part of the assembly just above the frame using the 10MM socket. Do this to both sides of the vehicle. Pull the headlight assemblies forward, unplug. Set bolts and headlight assemblies aside to be reinstalled later.

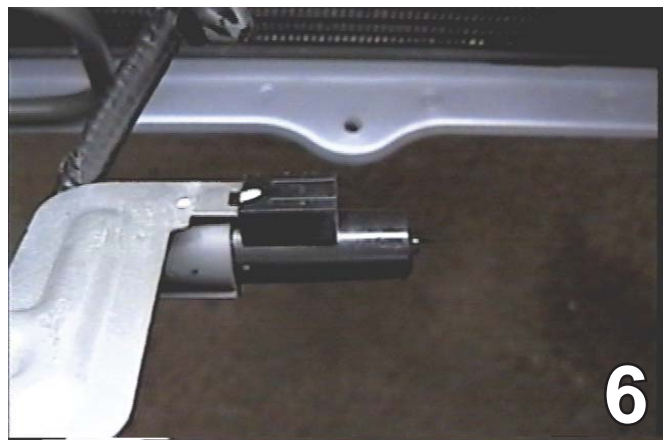

6. Using the small flat screwdriver, remove the temperature sensor and set out of the way to be reattached later.

BX1012
2004-05 Acura TSX
Installation Instructions

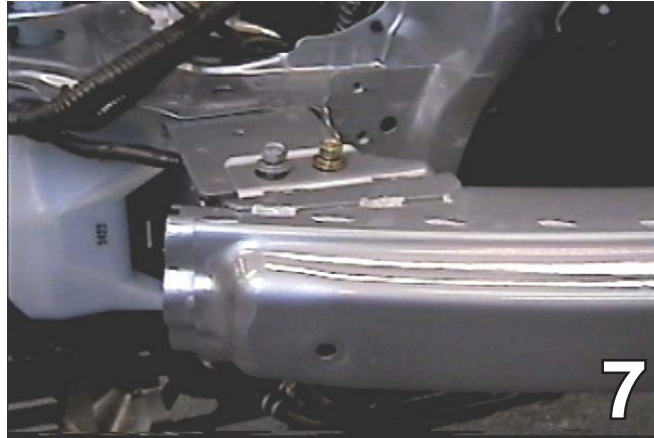

7. Using the 12MM socket, remove two metric bolts from the top of the metal bumper and one metric from the bottom. Set the bolts and the metal bumper aside to be reinstalled later.

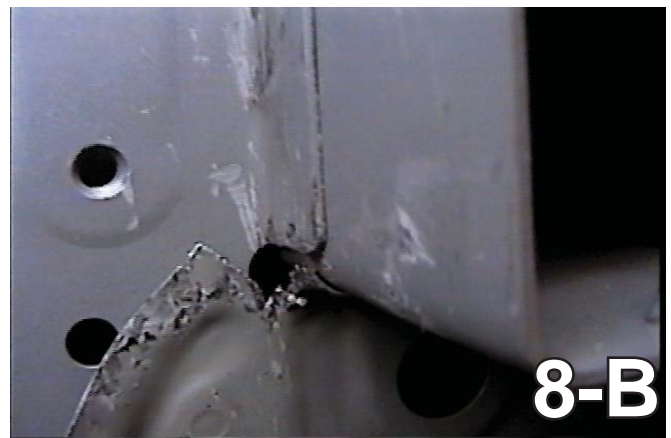

8. Using the baseplate as a template, drill four holes into each frame end with the 13/32" drill bit. Be sure NOT to drill out the forward reservoir hole. Check the hole location on page 2 for the 6MM-1.0 x 30MM hex bolt. Also drill the four marked holes on the bottom side of the metal bumper with the 13/32" drill bit. Insert the 3/8-16 nut plates into the frame ends to align with the 3/8-16 x 1 1/2" hex bolts and the 3/8" lock washers. Do NOT tighten the bolts. Be sure to use LOCTITE Red on ALL bolts before tightening.

BX1012
2004-05 Acura TSX
Installation Instructions

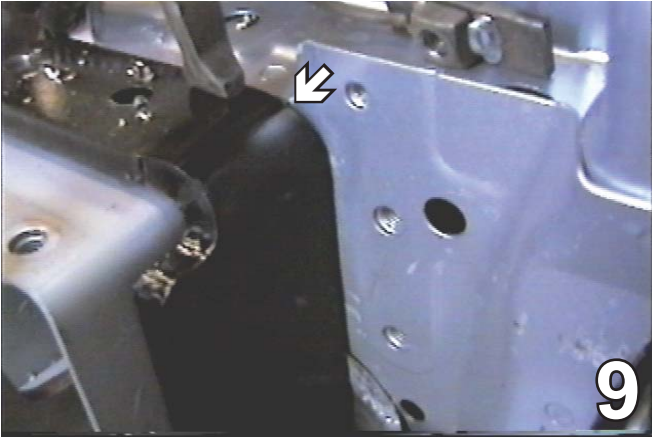

9. Cut the flat webbing on the top of the frame end. Do this to both sides of the vehicle.

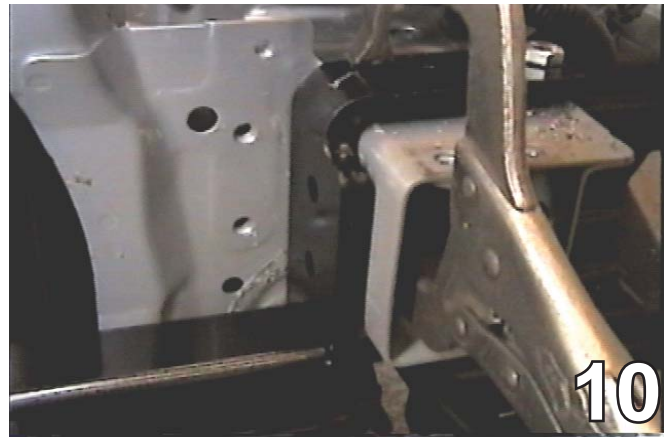

10. Set the baseplate in place on the frame ends as shown. Slide it as far back as possible and clamp it with the large vise grips. Do this to both sides of the vehicle.

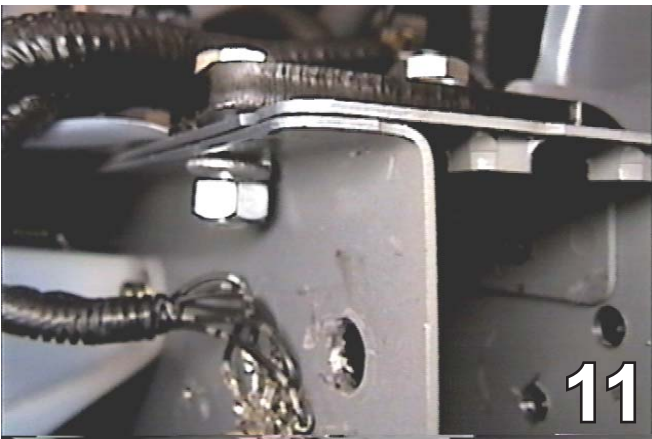

11. Using the baseplate as a template, drill the top two holes with the 13/32" drill bit. Do this to both sides of the vehicle. Install the 3/8-16 x 1 1/4" hex bolt, 3/8" lock washer, and the #10-32 hex nut into the frame end to align with the drilled holes and tighten the 3/8-16 x 1 1/2" hex bolt and lock washer. **Be sure to apply LOCTITE Red to ALL bolts before tightening. Tighten ALL bolts according to the torque chart in the Baseplate General Towing Instructions.**



12. Using the baseplate as a template, drill the rest of the holes with the 13/32" drill bit. Insert nut plates into the end of the frame to align with the drilled hole, tighten 3/8-16 x 1 1/2" hex bolts and 3/8" lock washers. Do this to both sides of the vehicle. **Be sure to apply LOCTITE Red to ALL bolts before tightening. Tighten ALL bolts according to the torque chart in the Baseplate General Towing Instructions.**

BX1012
2004-05 Acura TSX
Installation Instructions

13. Reinstall the metal bumper, headlight assemblies and the fascia. Be sure all electrical connections are plugged in properly.

Install the tow bar and safety cables according to the instructions included in their packages.

Do not substitute other devices if the tow bar pin and clip are lost.

DEALER OR INSTALLER: BE CERTAIN THE USER RECEIVES THE INSTRUCTION SHEETS.

Customer Service Commitment

Blue Ox® is focused on providing exemplary customer service, as observed in our mission statement and guiding principles. In accordance with this objective, Blue Ox® is proud to provide services such as repairs and general maintenance of Blue Ox® products at over 150 RV Rallies. Look for our Destination America or Blue Ox® Racing service crews at the next rally or race that you attend. If you were not present, you will find an informative, personalized note explaining any services that may have been performed to your Blue Ox® products.

Blue Ox® also offers educational seminars at rallies and through our Parks and Resort teams. In addition, Blue Ox® customers visiting our factory may take advantage of the well-equipped Blue Ox® RV park at no charge to you, our valued and appreciated customer.



© 2005 Blue Ox
One Mill Road, Industrial Park
Pender, Nebraska 68047
Phone: (402) 385-3051
Toll Free: (888) 425-5382
Fax: (402) 385-3360
www.blueox.us
7/31/08